

Using dispersant to treat oil slicks at sea

AIRBORNE AND SHIPBORNE TREATMENT

RESPONSE MANUAL



Cover photo: traces of dispersant in water
Source: Cedre

Using dispersant to treat oil slicks at sea

AIRBORNE AND SHIPBORNE TREATMENT

RESPONSE MANUAL

This guide was written and produced with the financial support of the Navy and the Ministry of Ecology and Sustainable Development. It replaces two guides on the same subject published in 1987 and 1991.

Editor: François Xavier Merlin

This guide is the result of research and experimentation conducted by *Cedre* which cannot be held liable for the consequences resulting from the use made of the information contained herein.

Published: December 2005

Purpose and structure of this guide

The dissemination of results generated by research, laboratory and field work and user feedback in Response Manual format is one of the cornerstones of the work conducted by *Cedre* and is a major priority for *Cedre's* Strategic Committee.

This guide replaces two others entitled «Manual for treating slicks with dispersants sprayed from surface vessels» and «Manual for treating slicks with dispersants sprayed from airborne assets» dating back to 1987 and 1991 respectively. It has become apparent for *Cedre*

experts and the organisations we cooperate with that there is currently a need to update our publications in the light of how techniques, technology and knowledge have developed, presenting the information in a more operational format for the purposes of response (cf. below).

This guide has been designed and produced for response specialists who will have to use dispersants during the course of their response operations.

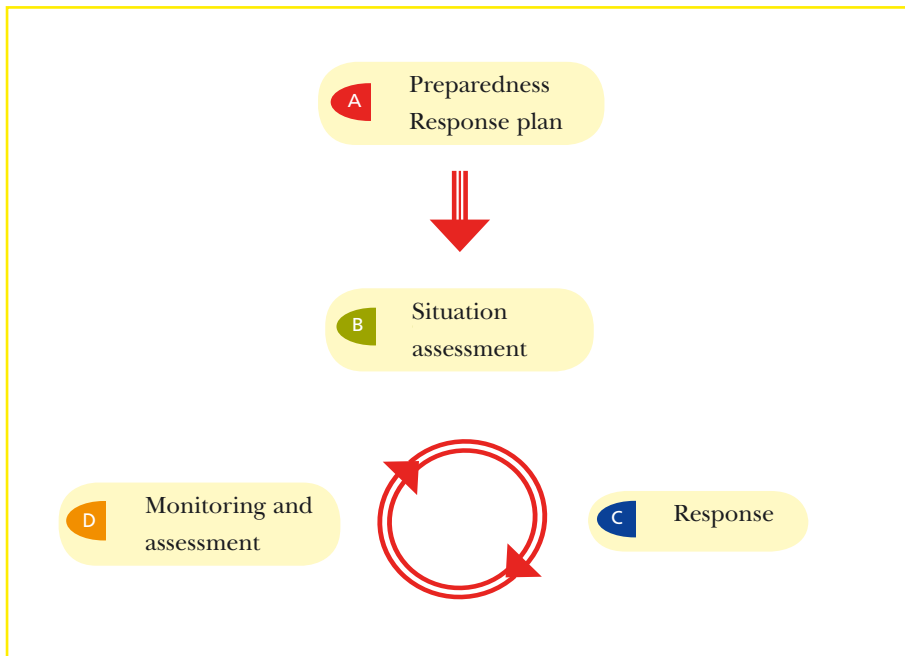

Table of contents

Purpose and structure of this guide	4
A PREPAREDNESS - RESPONSE PLAN	7
A.1 - Why use dispersants at all?	8
A.2 - How do dispersants work?	9
A.3 - When can you spray dispersants?	10
A.4 - Types of dispersants	12
A.5 - Regulations: dispersant certification	13
A.6 - Geographical limits regarding the use of dispersants	14
A.7 - Size of stockpiles and how to manage them	16
B SITUATION ASSESSMENT	17
B.1 - Slick characteristics	18
B.2 - Net Environmental Benefit Analysis (NEBA)	22
B.3 - Logistics requirements	24
B.4 - To spray or not to spray?	26
C RESPONSE	27
C.1 - How to apply dispersants?	28
C.2 - Airborne treatment	31
C.3 - Shipborne treatment	33
C.4 - How much dispersant to use when spraying from an aircraft?	36
C.5 - How much dispersant to use when spraying from a vessel?	38
C.6 - How to treat a slick?	40
C.7 - Technical matters requiring attention prior to treatment	46
C.8 - Precautionary measures	47
D MONITORING AND ASSESSMENT	48
D.1 - How do you assess treatment efficiency?	49
D.2 - Monitoring and assessment procedures	52
Bibliography and interesting web sites	53
Glossary	54

Preparedness - Response plan

A

- Why use dispersants at all? _____ **A1**
- How do dispersants work? _____ **A2**
- When can you spray dispersants? _____ **A3**
- Types of dispersants _____ **A4**
- Regulations: dispersant certification _____ **A5**
- Geographical limits regarding the use of dispersants _____ **A6**
- Size of stockpiles and how to manage them _____ **A7**

Why use dispersants at all?

A1

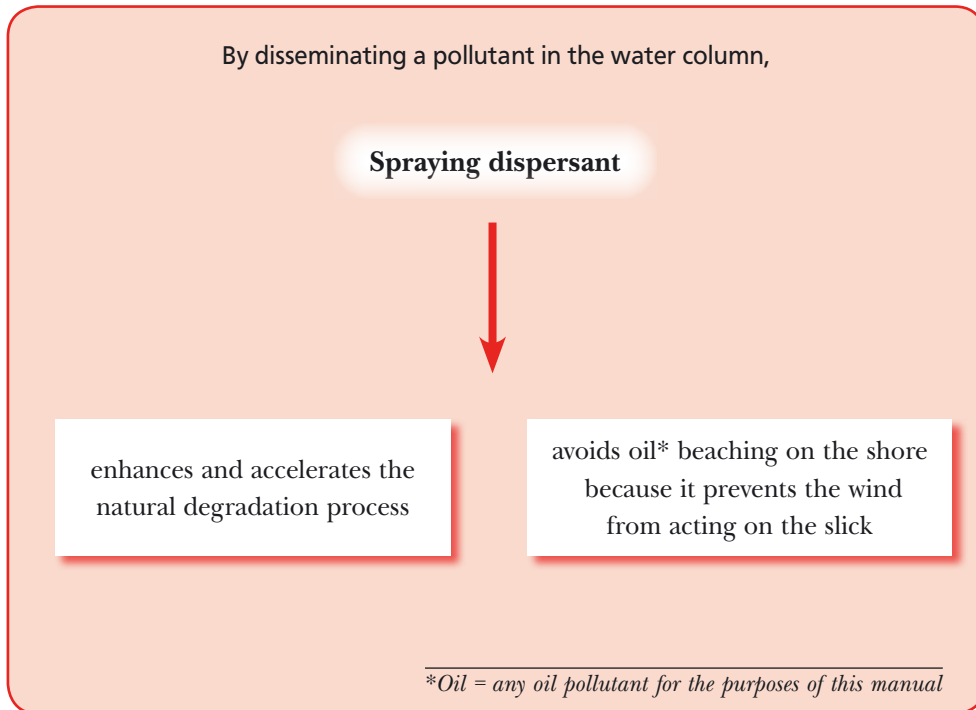

Important note: spraying dispersants removes oil from the water surface but does not cause the oil to disappear.

How do dispersants work?

Dispersants are liquid mixtures of solvents and surfactants.

The surfactants to be found in dispersants concentrate at the oil-water interface and alter the existing equilibrium between natural dispersion and emulsification: they «reduce» the formation of a reverse emulsion sometimes called a «chocolate mousse» (which contains water droplets in oil) and enhance dispersion (by fragmenting the surface oil film into droplets that are suspended in the water column).

In other words, the combined effect of spraying dispersants and the natural stirring process of sea contributes to reducing the formation of «chocolate mousse» and to increasing the extent to which oil is suspended in water: **this is the primary dispersion phase.**

Subsequently, the action of currents and natural turbulence will disseminate or «disperse» oil droplets in a larger volume of water: **this is the secondary dispersion phase.**

A2

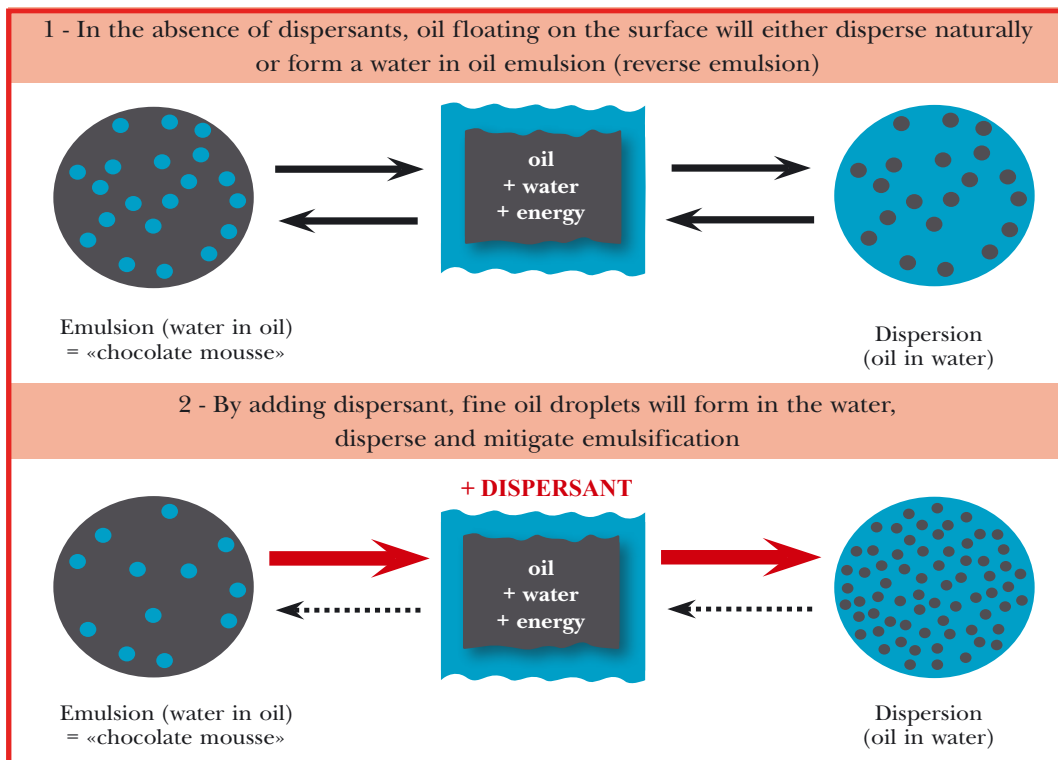

Dispersion and emulsification of oil in water with and without dispersant

When can you spray dispersants?

From the physical and chemical point of view

A3

- ▶ When the viscosity of the pollutant at seawater temperature is not too high

A pollutant weathers at sea:

- because its light fractions evaporate;
- and also because it forms a water in oil emulsion called «chocolate mousse».

When a pollutant weathers, its viscosity increases causing it to be far less amenable to dispersion.

This is what we call a «window of opportunity» or «dispersion window» meaning the interval during which a pollutant is dispersible.

Treating without delay is therefore of the essence.

Generally accepted viscosity limits

Pollutant viscosity < 500 cSt

Dispersion is generally easy with a concentrated dispersant, applied neat or prediluted in seawater

500 cSt < Pollutant viscosity < 5 000 cSt

Dispersion is usually possible with a concentrated dispersant applied neat

5 000 cSt < Pollutant viscosity < 10 000 cSt

Uncertainty as to the result: dispersion is sometimes possible with a concentrate applied neat but you had better check on part of the slick whether the dispersant is effective before extending the treatment to all of the slick

Viscosity > 10 000 cSt

Dispersion is generally impossible

- ▶ Paraffinic (waxy) oil: oil that solidify very quickly below a given temperature (pour point)

Dispersion is impossible when the temperature is 4 to 8 degrees below pour point.

- ▶ Light product: petrol - diesel - kerosene

Treatment is possible, but to no avail more often than not (the pollutant disappears because it evaporates or disperses naturally).

- ▶ Newly formed (fresh) emulsion

cf. C4 - How much dispersant to use when spraying from an aircraft? - Note 1 page 36

► **When surface agitation is sufficient**

A choppy sea (caused by the wind) can generate surface agitation that is likely to break oil down into droplets.

Dispersion is impossible in sea state 0, and difficult in sea states 1 and 2.

Note: if there is virtually no surface agitation, the pollutant will almost always resurface.

Note: when the weather is too rough (sea state > 4 for shipborne treatment, wind > force 7 when spraying from an airplane or a helicopter), spraying dispersant will turn out to be unfeasible because the spray will be blown over and away from the oil by the wind or else the vessel will pitch and roll too much and make spraying operations very difficult.

If there is not enough surface agitation, dispersion can be initiated by effective stirring processes:

- using special equipment:
 - floating breaker boards, plastic chain, that you trawl over the surface during the course of the spraying operation;
- by manoeuvring swiftly through the slick:
 - which will take quite some time and only be feasible on small slicks, after spraying dispersant;
- with a fire hose and a solid water jet:
 - only for small patches once dispersant spraying is completed.

From the environmental point of view

► **When «dilution - dissemination» conditions are met**

Sea currents must enable droplet dissemination in a vast volume of water.

The use of dispersants can constitute a risk for the environment in some cases by potentiating oil toxicity locally. This effect will last as long as the dispersed oil (in suspension in the water column) has not been disseminated or «diluted» down to harmless concentrations. For all these reasons, dispersant spraying is not appropriate in nearby or adjacent sensi-

tive areas, or in places where the dilution factor is too small (shallow waters or confined water area) which is what you generally observe near the coastline.

cf. A6 - Geographical limits regarding the use of dispersants

cf. B2 - Net Environmental benefit analysis (NEBA)

Types of dispersants

Nowadays there are two types of dispersant:

Conventional dispersant (2nd generation)

- ▶ These have a low surfactant content in a non water soluble hydrocarbon solvent.

They are used at a dispersant to oil ratio of 30 to 100%, are not pre-diluted and are used very rarely.

These dispersants have been gradually phased out and been replaced by concentrates.

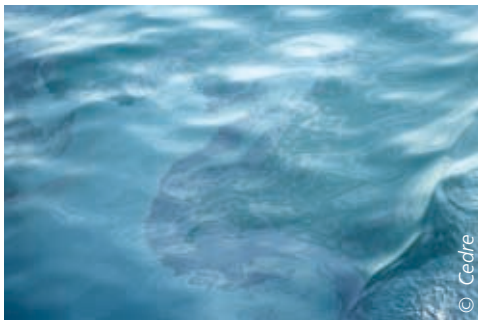

Concentrates (3rd generation)

- ▶ These dispersants are far more recent, have a higher surfactant content in solvents that are soluble in water.

For instance, in France, the Navy only uses this kind of dispersant.

The dispersant to oil ratio is 5 to 10% (15% in special circumstances).

They can be sprayed neat or pre-diluted in seawater as they are soluble or can easily emulsify in seawater. They are better sprayed neat as they will be more effective on weathered, viscous or difficult-to-disperse oil.

► cf. C5 - How much dispersant to use when spraying from a vessel?

When spraying from an aircraft only use concentrates neat.

United Kingdom use a classification that factors in how dispersants are sprayed.

Type 1 dispersant

Conventional dispersant (2nd generation)

Type 2 dispersant

Concentrate dispersant (3rd generation) sprayed pre-diluted in seawater

Type 3 dispersant

Concentrate dispersant (3rd generation) sprayed neat

Note: In some countries dispersants are quality controlled (approval/certification): make sure you only use approved or recommended dispersants.

cf. A5 - Regulations: dispersant certification

Regulation: dispersant certification

You will often have to comply with rules governing the use of dispersants. As a rule, **only approved, certified, or tried and tested** dispersants will be allowed.

The procedure involves one or several of the following tests:

- efficiency;
- toxicity of the dispersant and/or the oil+dispersant mixture;
- dispersant biodegradability.

In France, dispersants are tested as follows:

- ▶ Measuring dispersant efficiency
(*NF.T.90-345*)
- ▶ Testing intrinsic dispersant toxicity
(using shrimps)
(*NF.T.90-349*)
- ▶ Testing dispersant biodegradability
(*NF.T.90-346*)

The list of tried and tested dispersants can be downloaded from the website (Response section):
<http://www.cedre.fr>

A5

There are other websites belonging to organisations such as ITOPF, REMPEC, the Bonn Agreement and the US-EPA that contain information on international regulations

International Tanker Owners Pollution Federation (ITOPF):
<http://www.itopf.com>

Regional Marine Pollution Emergency Response Centre for the Mediterranean Sea (REMPEC):
<http://www.rempec.org>

Bonn Agreement:
<http://www.bonnagreement.org>

Environmental Protection Agency (US-EPA):
<http://www.epa.gov>

Geographical limits regarding the use of dispersants

A6

There may well be a ban on using dispersants in certain areas along the coastline, or else they may be limited or subject to prior certification. Such measures are taken in a bid to protect the environment, they involve:

- guaranteeing sufficient dilution conditions so that dispersed oil concentrations remain harmless;
- avoiding the most ecologically sensitive areas (estuaries, fishing grounds and mariculture areas) or industrially sensitive areas (power station and desalination plant water intakes...).

cf. B2 - Environmental benefit analysis (NEBA)

Protected areas are usually defined according to water depths and distance from the shoreline. They can also factor in local environmental characteristics (such as habitat sensitivity, seasonal characteristics: migration patterns, fisheries).

For example, in The United Kingdom, the 20 metre isobath line and a distance of 1 nautical mile from the coastline are taken as the baseline.

In France, *Cedre* has defined 3 limits for the free use of dispersant defined by *Cedre*, applying to increasing spill sizes: dispersing 10, 100 and 1 000 tonnes of oil. Beyond 1 000 tonnes, the decision is made by the «PC POLMAR» (POLMAR HQ). These limits consider water depth, minimum distance from the shore and the presence of ecologically sensitive assets (such as aquaculture, and marine reserves...).

Amount of pollution to be dispersed	Minimum depth (metres)	Minimum distance from shore (nautical mile)
<i>Up to 10 tonnes of oil</i>	5	0.5
<i>Up to 100 tonnes of oil</i>	10	1
<i>Up to 1 000 tonnes of oil</i>	15	2.5

Basic rules defining geographical limits regarding the use of dispersant along the shoreline of mainland France excluding specially sensitive areas

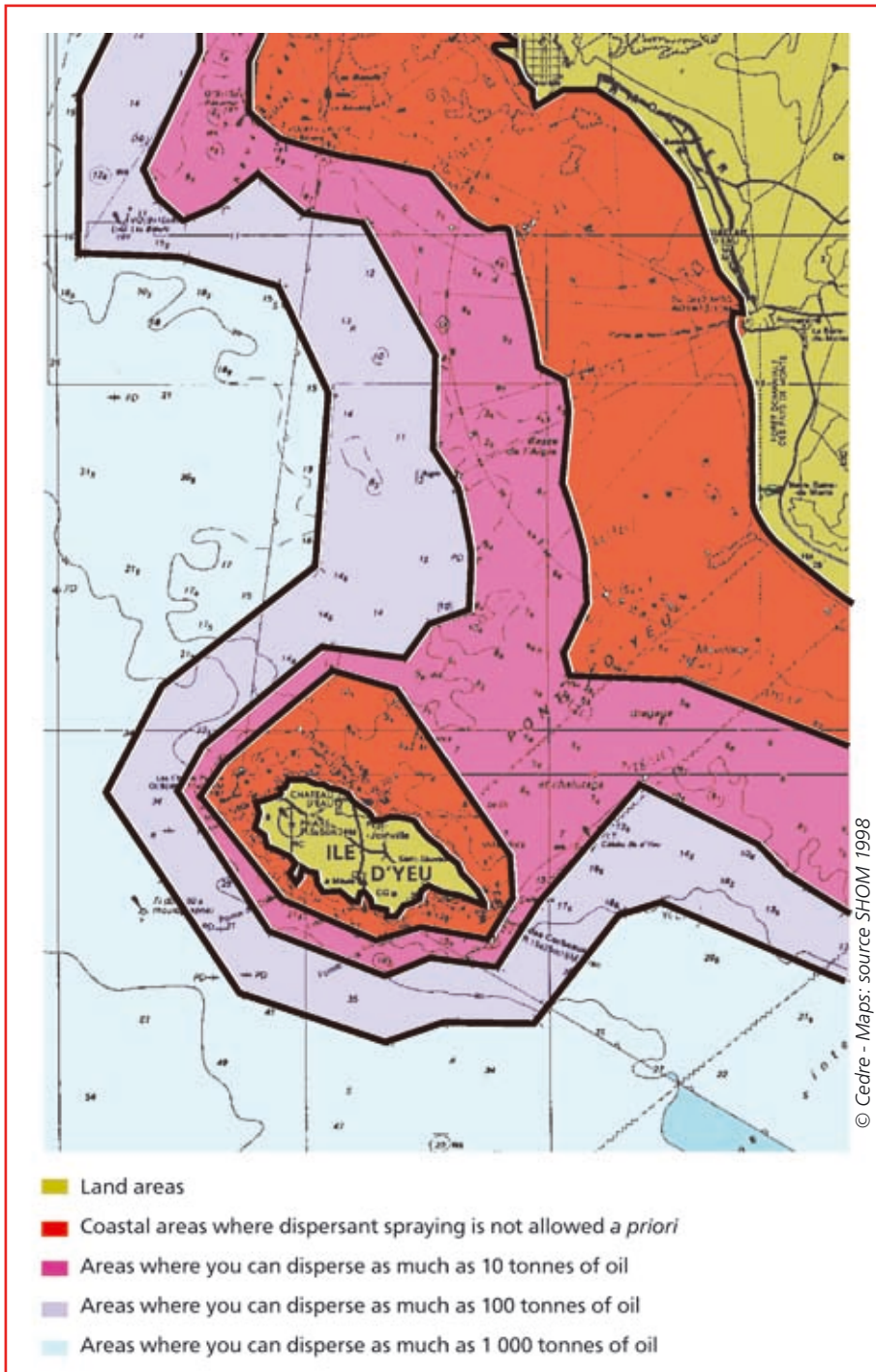

Definition of the 3 geographical limits used in France

Size of stockpiles and how to manage them

A7

Size of stockpiles

To have readily available dispersant, it is far better to have a sufficient amount of emergency dispersant stock, without overdoing it.

To optimise dispersant stocks, we can use the following reasoning:

Local stocks

Wherever there is a facility that can house or accommodate treatment vessels or aircrafts (vectors: harbours or airports, for instance) it must stock enough dispersant to allow responders to deal continuously with a spill for at least one day with the vectors in question.

Central stock(s)

Additional dispersants required for responding on the following day can be shipped in from one or several stockpiles providing they are packed accordingly (rail tanker, containers that can be loaded very quickly on trailers) and can be shipped during the course of the first day so as to replenish the response vessels and aircrafts.

Beyond this, measures will have to be taken to ensure that dispersant can be shipped from other stockpiles that have been set up in advance in various harbours or airports. Finally, additional dispersant (admittedly in limited quantities) will have to be secured from manufacturers.

Dispersants stored in 200 litre drums



Managing stocks

The shelf life for dispersants is limited (to 5 or 6 years according to manufacturers but in actual fact more than 10 years providing storage conditions are good).

Periodical testing will ensure that dispersants stockpiles are still effective (in France, 5 years after purchase, then every two years thereafter).

The testing can be done in two separate phases :

- Visual inspection of each batch pointing out any changes in the physical characteristics of the dispersant (appearance, deposits, density and viscosity).
- Batch efficacy testing, and if necessary, toxicity testing of the batches that have undergone changes to their physical characteristics.

You are strongly advised NOT to mix dispersants, be they of the same generation or type, as this can lead to product instability over time (phase separation).

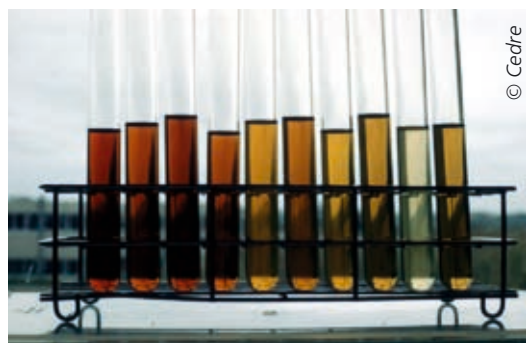

Lab dispersants testing

Situation assessment

- Slick characteristics _____ **B1**
- Net Environmental Benefit Analysis (NEBA) _____ **B2**
- Logistics requirements _____ **B3**
- To spray or not to spray? _____ **B4**



Slicks characteristics

In order to optimise response, there is a need to appraise the thickness, the shape and the nature of the oil slick to be treated depending on what the slick looks like and how it behaves.

► The Bonn Agreement Oil Appearance Code

Research conducted by the Bonn Agreement has led to the adoption of an oil appearance code. This code is the result of scientific endeavour seeking to determine spilled oil

quantities on the basis of aerial observation and should be used in preference to any other code.

B1

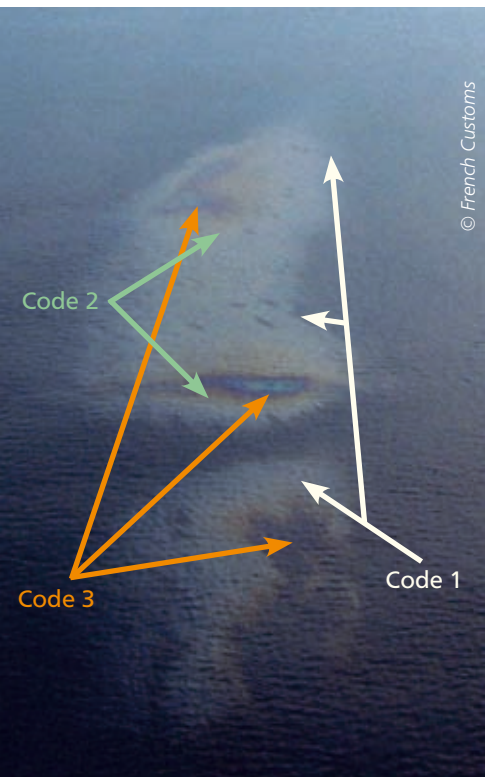

Description Appearance	Layer Thickness Interval (µm)	Litres per km ²
1. Sheen (silvery/grey)	0.04 to 0.30	40 – 300
2. Rainbow	0.30 to 5.0	300 – 5 000
3. Metallic	5.0 to 50	5 000 – 50,000
4. Discontinuous True Oil Colour	50 to 200	50 000 - 200 000
5. Continuous True Oil Colour	200 to more than 200	200 000 - More than 200 000

This code applies since January 2004 and is used for characterising slick thickness and assessing spills.

For further information,
Please refer to our operational guide
entitled : "Aerial Observation of Oil Pollution
at Sea", (© Cedre, 2004)

► Topography of oil slicks

For relatively fresh slicks, (from a few hours to a few days) the shape and the thickness distribution (small, average, large) essentially depend on the wind which spreads and lengthens slicks and even cuts them up into parallel swathes and fragments them.

Large thicknesses (codes 4 and 5) will be found downwind.

If the wind is very strong, sheen areas (silvery grey, rainbow and metallic: codes 1, 2 and 3) tend to disappear.

B1

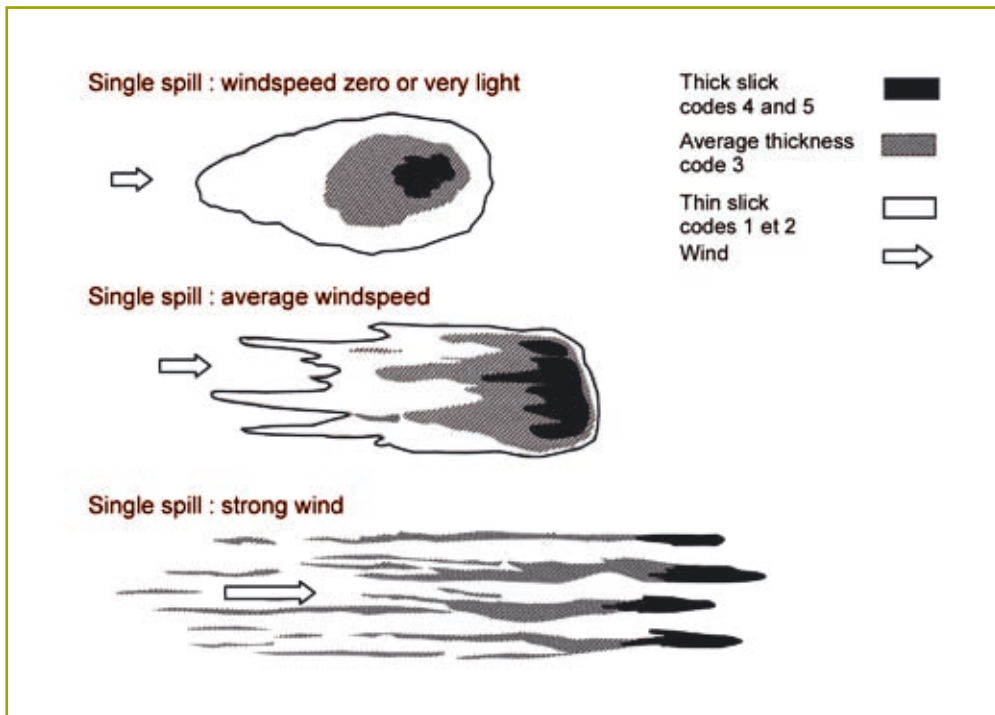

When slicks have had a chance to weather (for a week or more) the silvery grey, rainbow and metallic films (codes 1, 2 and 3) disappear. All that is left is very thick patches of oil that have a very hard time floating on the water surface (codes 4 and 5).

In the event of a heavy storm, it can happen that slicks are impossible to spot even if they are very thick. In some cases they are just

below the surface and upwell when weather improves or when water temperatures increase. Breaking waves can also fragment the patches to such a degree that they end up as scattered tar balls that are much harder to spot because they are so small.

Very weathered slicks are often found mixed with floating waste.

B1

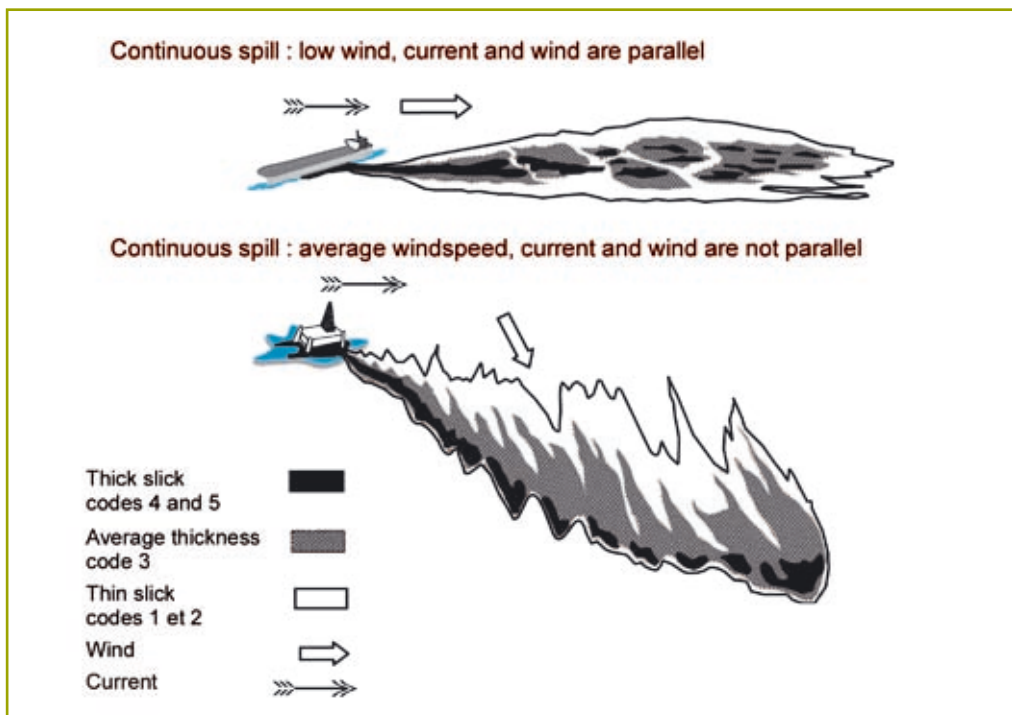

► Slick drift

Slicks drift on the water surface at a rate of about 3 per cent of the wind speed and 100 per cent of the surface current speed.

on a graph by vector addition hour after hour of the current speed and about 3 per cent of the wind speed

The itinerary followed by a slick or what is called its «ground track» can be worked out

	Current	Wind	Drift
1 st hour	1,5 kn 340°	12 kn 298°	
2 nd hour	1,5 kn 57°	30 kn 244°	
3 rd hour	1 kn 117°	25 kn 185°	
4 th hour	1 kn 193°	20 kn 125°	

Slick drift calculation over four hours

*The black arrows indicate the successive effect of current speed (100%) and wind speed (3%) on the slick in steps of one hour
The blue and orange arrows show the resulting drift after 4 hours. The red arrow shows the overall resulting drift pattern
The table shows the bearing of the current (where it is going) and wind direction (where it is coming from)*

Some software drift calculation packages can plot forecasted drift and can be useful for planning a response operation. Cedre uses the MOTHY model used by the French Weather Bureau (Météo France) in Toulouse.

Net Environmental Benefit Analysis (NEBA)

Before deciding on which response strategy to choose, it is often timely to see whether the response will mitigate the pollution and improve the situation or whether it is better to leave

well alone and refrain from responding. This approach is called NEBA (Net Environmental Benefit Analysis).

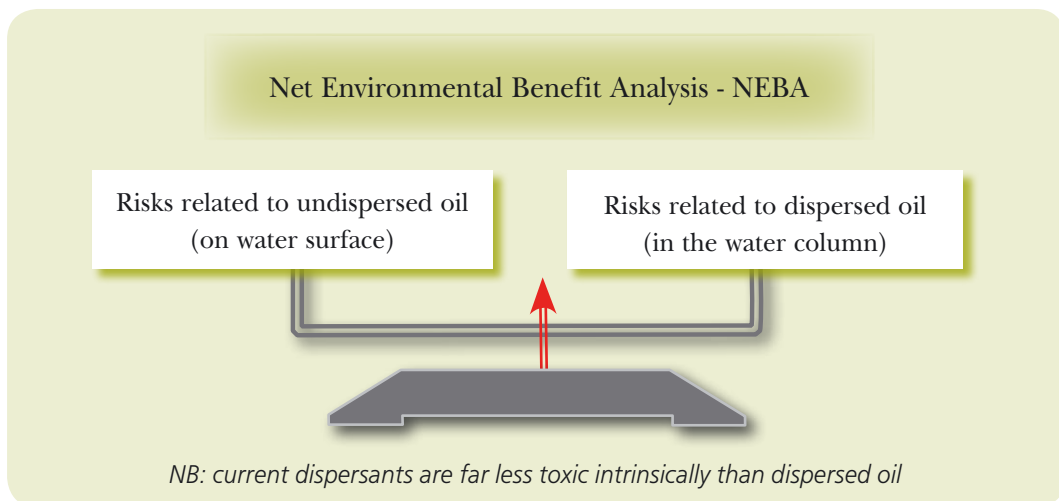

B2

The impact of the dispersed oil has to be less than that of non dispersed oil. Dispersed oil is more dangerous for the aquatic fauna and flora (corals, fish farm water intakes and industrial water intakes) than oil floating on the water surface.

On the other hand, dispersed oil is less detrimental than free-floating surface oil for seabirds and some habitats such as mangrove swamps.

The sensitivity of some habitats and marine resources in regard to dispersion has been described in an IMO Manual called «IMO/ UNEP Guidelines on Oil Spill Dispersant Application including Environmental Considerations».

cf. chapter 3 «Taking decisions when the spill occurs»

Depending on the situation, particularly dilution (current, water depths, distance from the coast) and local features (coastline, nature reserves, spawning grounds, fishing grounds, aquaculture, tourist amenities, industrial areas) spraying dispersant may or may not be desirable.

Defining areas where it is possible to disperse is tantamount to doing a «net environmental benefit analysis» or an «ecological advantage analysis» of dispersant spraying for set scenarios.

cf. A6 - Geographical limits on the use of dispersants

Once these items have been logged in a response plan they enable you to take a quick well supported decision in the event of a marine casualty.

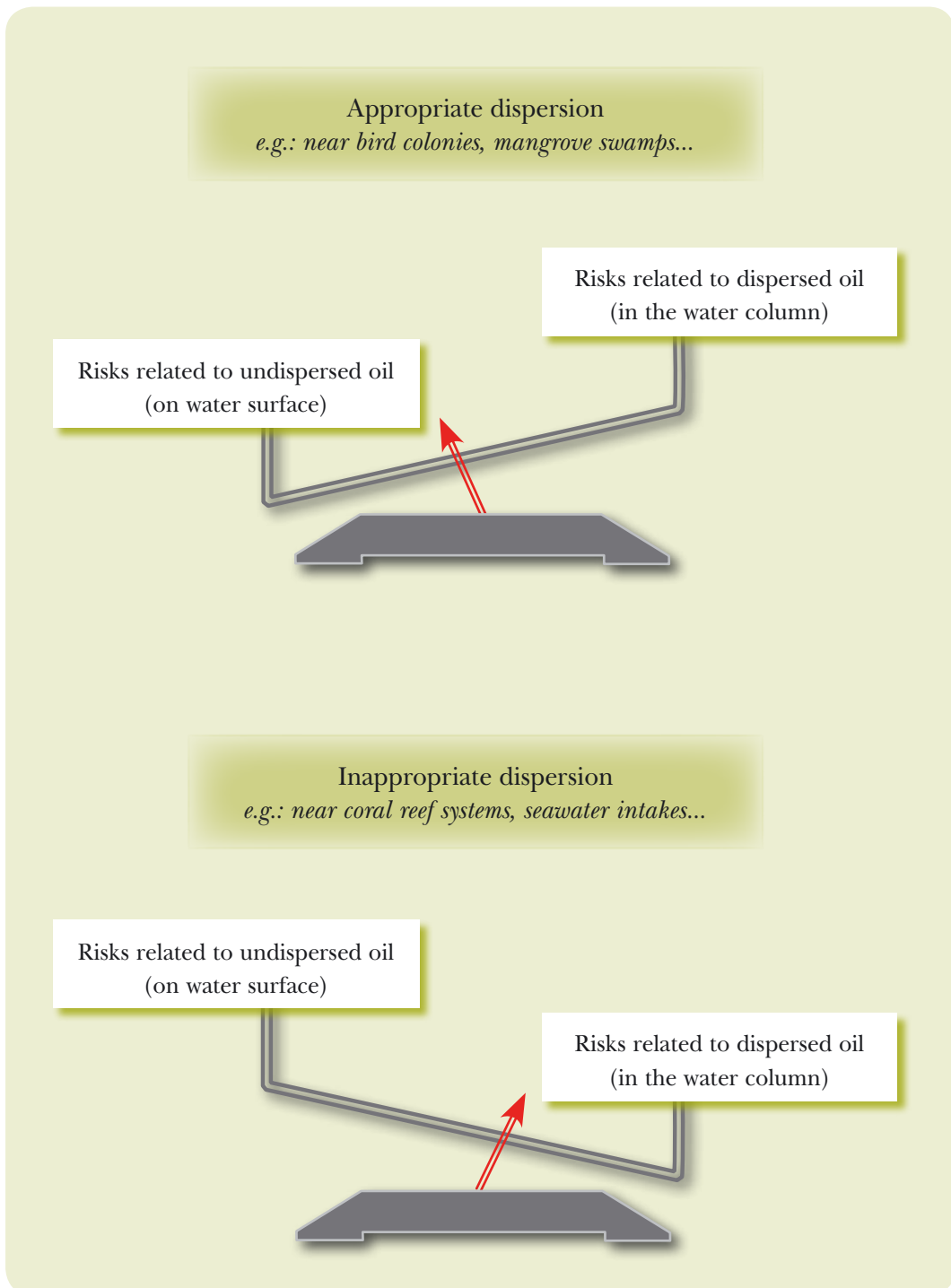

The IPIECA Volume 5 entitled «Dispersants and their role in oil spill response» gives a number of scenarios and relevant decisions.
cf. the scenarios on pages 28 - 29

Logistics requirements

Airborne treatment

In addition to the regular logistics required by airplanes and helicopters (airport with a sufficiently long and load bearing capacity runway, helipad, aviation fuel, safety...) the necessary measures will have to be taken to secure dispersant supplies.

- ▶ **Transport** (overland) to get the dispersant to the helipad or the runway;
- ▶ **Pumping units** for loading and unloading dispersant;

Note: some equipment may or may not be dispersant resistant such as: pump check valves and seals, hosepipes, compatible connectors for loading nozzles...

cf. C2 - page 32 - Spraying equipment: nozzles and check valves

- ▶ **Storage facility** for dispersant alongside the runway or helipad (tanks, drums...);
- ▶ **Aerial guidance** is desirable for letting the aircraft know where to spray the dispersant: when and where to spray.

Helicopter: need for a forward operations helipad

Helicopters are limited in terms of payload and range which is why it is always better to have a helipad as near as possible to the area where the dispersant will be sprayed (helipad on the coast, production platform, suitable maritime platform).



A Super Frelon heavy duty helicopter fitted with a SOKAF Bucket spraying device on location

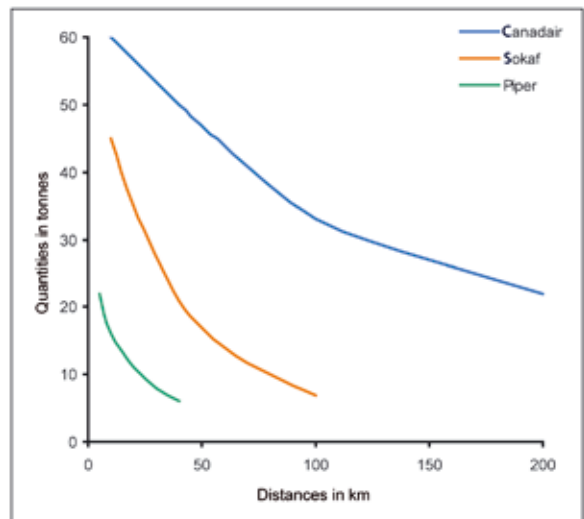

Comparative assessment of how much dispersant can be sprayed in 8 hours by a Canadair twin engine water bomber, a small single engine Piper crop duster and a heavy duty helicopter fitted with a SOKAF Bucket dispersant spraying system on a sling (the calculations include 10 minutes reconnaissance flight time over the slick prior to spraying...)

Shipborne treatment

In addition to the dispersant itself, logistic support will be needed for shipborne treatment operations.

► Spraying equipment

Treatment using dispersant neat (concentrate or conventional):

- a spraying system, often a spray boom: set of nozzles, preferably fitted with check valves and mounted on arms that are secured by one or two small masts;
- a feed pump;
- a filter for eliminating solids likely to clog the nozzles.

For treatment using (concentrate) dispersant that has been prediluted in seawater:

- a spraying system, as mentioned above;
- a seawater feed system either via a pump or the vessel's own firefighting system;
- a system that can mix dispersant and seawater (at a ratio of at least 10 per cent) which can be a metering pump or a simple «venturi».

► A system for fixing the equipment on board

- to avoid wasting time, there must be a preset connection set-up for the spraying system on board.

In this connection there is a French standard called «flange for fixing dispersant spraying systems on board vessels - NF.T.71-400» that can be referred to.

► One or several dispersant storage capacities

- the dispersant can be stored either on deck in drums, tanks or else directly in the ships'tanks. Care will be taken to check that all the pipes and connectors and their respective seals are available, in working order and made of dispersant resistant materials.

► Aerial guidance

- for dispersion and recovery, vessels need to be guided by aircraft onto the area to be treated. Vessels are very close to the water surface and as such have a very hard time trying to locate the patches of oil or the slick. Furthermore, the radio equipment will be checked to ensure compatibility between the sets used on board the vessel and those used by the pilots (UHF – VHF).

cf. C6 - page 45 - Aerial guidance procedure

To spray or not to spray?

The decision to spray or not has to be taken before the oil can weather and become no longer amenable to dispersion or before it can reach the coast. A well founded decision will require doing a NEBA. This isn't always simple and it can take time.

cf. A3 - When can you spray dispersants?

cf. B2 - Environmental Benefit Analysis (NEBA)

The decision can be taken based on three simple questions (cf. table below). All three can be answered by comparing the information on the spill itself (in red) and issues contained in the response plan (in blue).

B4

The spraying can only be undertaken if all three questions get a positive answer

1 • «Is dispersion possible?»
(physically and/or chemically)
or «is the oil dispersible?»

.....▶ **Information about the oil**
Decision criteria
(viscosity limits)

2 • «Is dispersion acceptable?»
(environmentally)
or «won't the impact of dispersed oil be worse than the pollution itself?»

.....▶ **Location of the spill**
Geographical limits on dispersion

3 • «Is dispersion feasible?»
(logistically)
or «do I have what I need to complete dispersion?»

.....▶ **Quantity of oil to be dispersed**
Available * dispersants and spraying gear
.....▶ **Local weather conditions**
Operational limits of the spraying gear

* In this case, available includes transit time for the equipment which should be compatible with the window of opportunity for dispersion

Response

- How to apply dispersants? _____ C1
- Airborne treatment _____ C2
- Shipborne treatment _____ C3
- How much dispersant to use when spraying from an aircraft? _____ C4
- How much dispersant to use when spraying from a vessel? _____ C5
- How to treat a slick? _____ C6
- Technical matters requiring attention prior to treatment _____ C7
- Precautionary measures _____ C8



How to apply dispersants?

Possible vectors for applying dispersants.

Dispersants can be used by ships, helicopters and planes (small, average or large size). These vectors all afford different operational options.

Aircraft

Aircraft always use neat dispersant.

Features

- ▶ Rapidity: they can get to the scene of operations very quickly and get the job done whilst the oil is still amenable to dispersion.
- ▶ High prospection rate: they can spray large areas quickly.
- ▶ They can spray even in bad weather.
- ▶ The need for aerial guidance may well be less: if the plane is flying too low over the sea to actually see the slick when spraying, it can, from time to time, climb higher and spot the slick in between two passes.

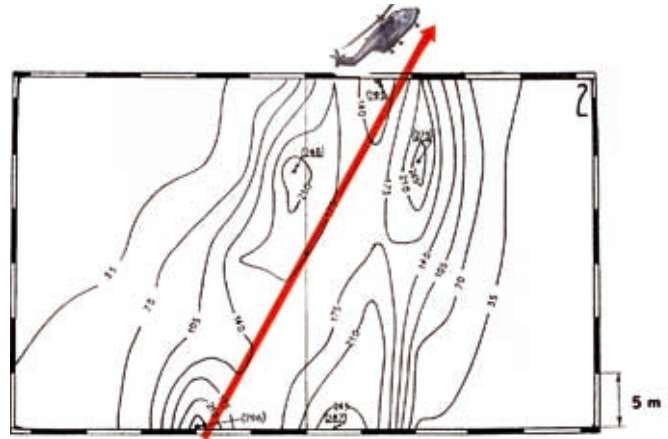

The litres per hectare iso-spraying curve for a SOKAF Bucket dispersant spraying system (mesh size of the map is 5 metres for a spraying rate in litres per hectare)

But

- ▶ Uneven spraying (cf. figure above) and dispersant losses may well reach as high as 50 per cent: as dispersant is sprayed at a height of anywhere between 10 and 30 metres above the sea surface, part of the dispersant is more or less lost and does not reach the slick.

Situation with helicopters

Helicopter payload capacities drop very quickly when transit distances increase.

C1



Calibration trials on the ground for dispersant spraying PROTECMAR trials

Vessels

Spraying equipment for vessels can use neat dispersant or, (with older equipment) spray dispersant once it has been prediluted in seawater. Using dispersant neat is preferred to predilution as it is more effective on weathered and/or emulsified oil.

cf. C5 - How much dispersant to use when spraying from a vessel?

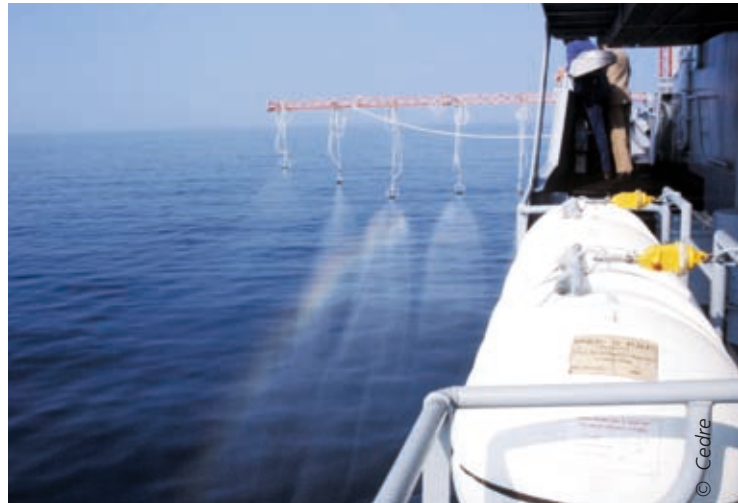

Spray boom in full swing

Items to note

- ▶ Slow response: unless you're having to treat a slick in the immediate vicinity, a vessel needs time to reach the scene of operations which means that the chances of being able to spray the slick during the requisite window of opportunity during which the oil will be amenable to dispersion will be slighter.
- ▶ Low prospection rate (in hectares treated per hour): simply because vessels cannot manage more than 4 to 6 knots (rarely 8) knots.
- ▶ Sensitivity to sea state: as soon as the sea state gets a little rough, vessel manoeuvres slow down. Furthermore, as dispersants produce a herding effect, vessels have to spray into the wind, which is not a very comfortable option especially when sea conditions are poor.

cf. C3 - page 35 - Dispersant can contract surface oil

But

- ▶ The stirring effect produced by the bow wave can help to initiate dispersion if the sea is too calm.
- ▶ They can treat very fragmented slicks if they have aerial guidance to spot them.
- ▶ They can help to calibrate dispersant spray rates (litres per hectare) either by changing vessel speed or better yet by using special spraying equipment (multiple boom spraying arrays).
- ▶ They can treat oil for long periods of time without needing to replenish.

C1

Dispersant must come into physical contact with oil and must be sprayed.

Dispersant spraying has to be geared so as to obtain an even application pattern and an optimum dispersant-oil contact.

- ▶ If the droplets of dispersant are too big they will simply traverse the slick and be wasted in the water column.
- ▶ If they are too small, the wind will cause them to drift away away.



Dispersant spraying modes for vessels, planes and helicopters

Airborne treatment

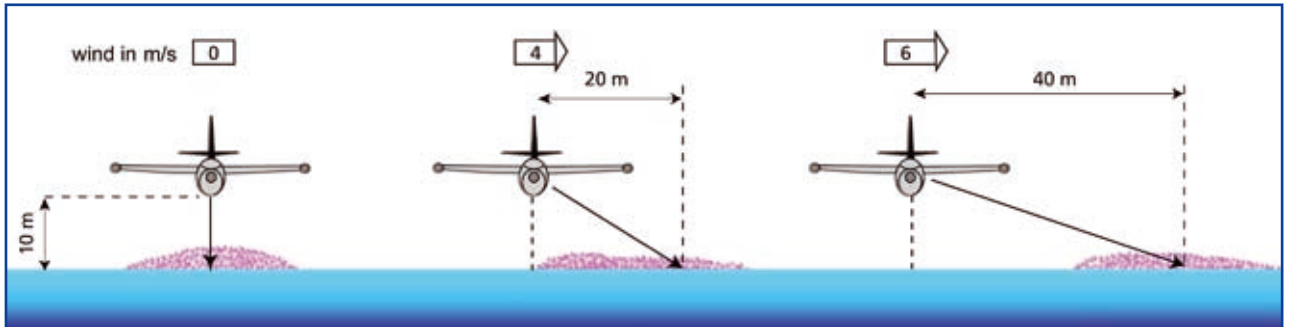

NB: the use of smoke bombs helps to materialise wind direction and comply with these instructions.

➔ *cf. box page 44 - C6 - Prior reconnaissance, guidance and marking*

To avoid dispersant wastage (wind carries the dispersant away from the slick), the recommendation is generally to use droplet sizes of between 400 and 700 μm in diameter.

This result can be achieved by the use of the right kind of spraying equipment.

cf. box page 32 - C2 - Spraying equipment: nozzles and check valves

Note: wind conditions can make spraying difficult and ineffective because dispersant droplets are blown by the wind as they are dropping onto the slick and a cross wind will push the dispersants away from the slick that is being targeted.

Instructions: during treatment operations, always fly upwind or downwind at the height recommended for the type of plane you are flying.

Spraying equipment: nozzles and check valves

Nozzles

Dispersant spraying equipment generally involves the use of spraying booms fitted with calibrated nozzles that generally produce flat jets. In this case the nozzles must be placed at an angle of anywhere between 10° and 15° in relation to the spray boom in order to generate non crossing parallel jets.

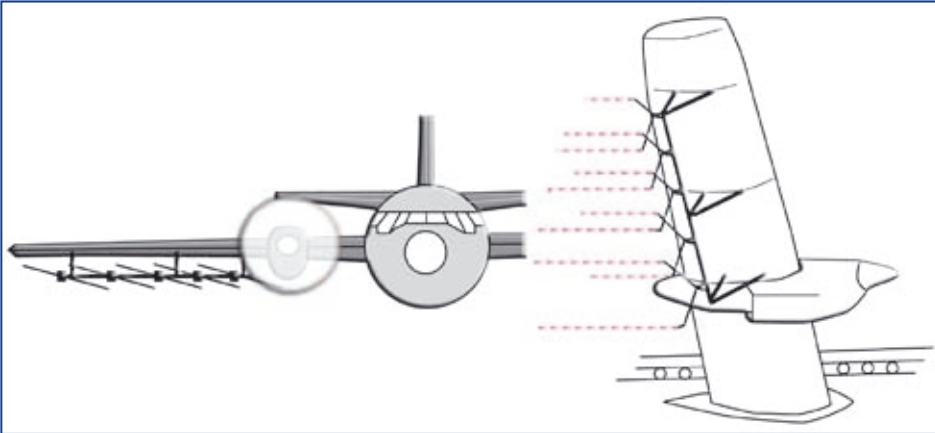

No-drip check valves

Check valves are often mounted on the spray system upstream of the nozzles and close when the system pressure in the spray boom drops. This will avoid leaks and keep the spray system under pressure and full of dispersant when the spraying operation stops. Note: clean check valves make for optimum spraying.

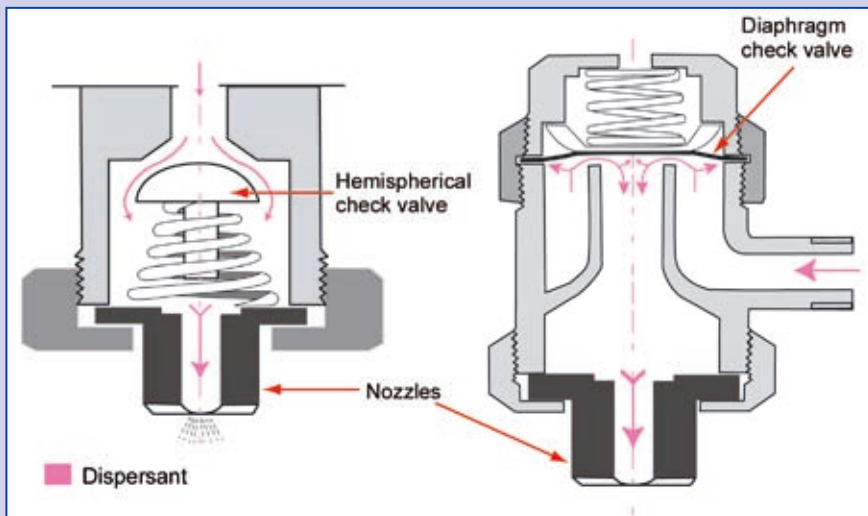

Shipborne treatment

Dispersant has to come into physical contact with oil.

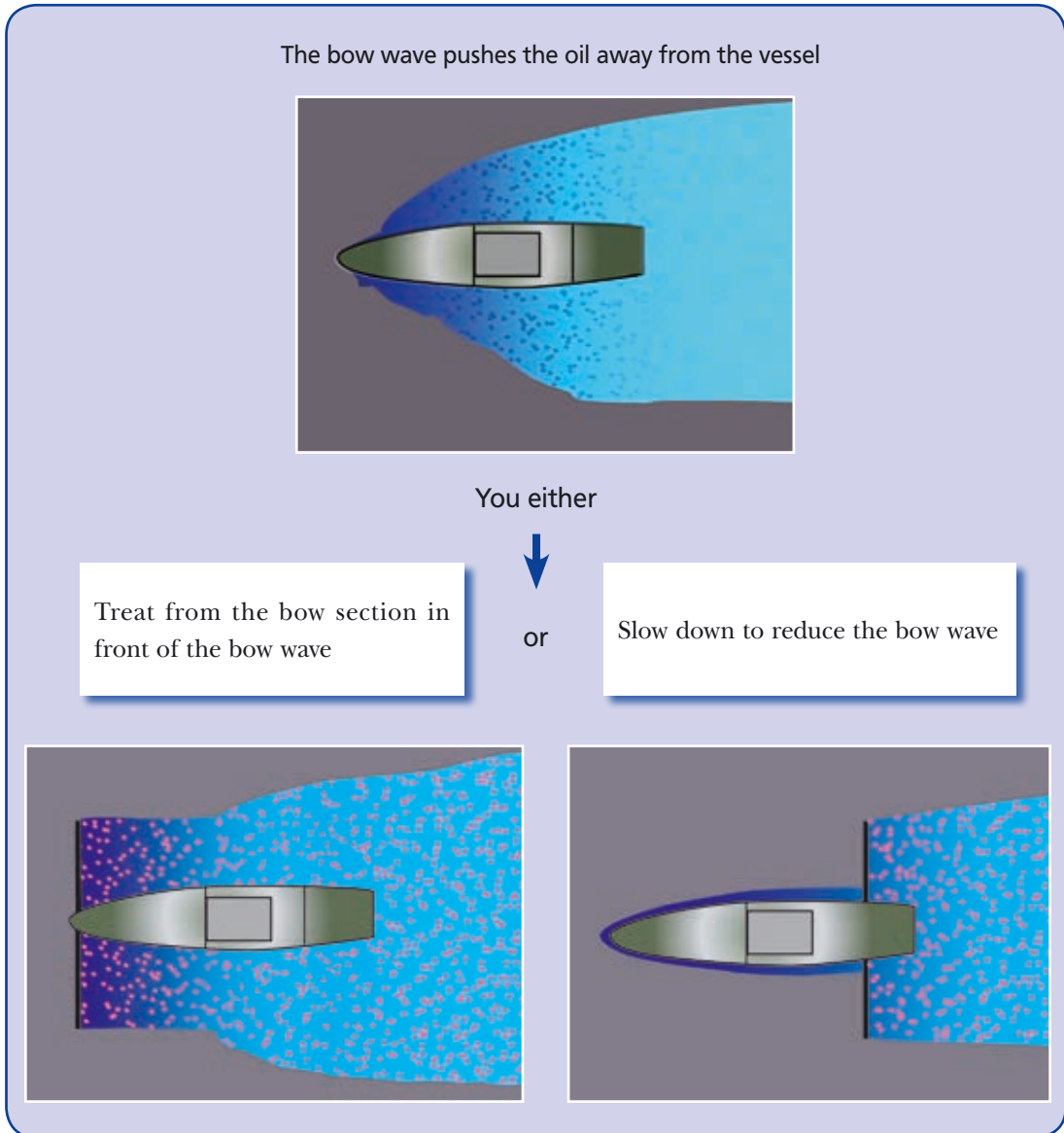

Bow wave as well as ship pitch push the oil away from the vessel and out of reach of the spray booms. Furthermore, the bow wave must not herd the dispersant before it has had a chance

of penetrating the oil. The more viscous the oil is, the longer it takes the dispersant to penetrate the oil. In this case you will need to slow the vessel down.

Dispersant has to be sprayed on the oil.

Dispersant droplets must not be too small or too big in order to settle gently onto the oil.

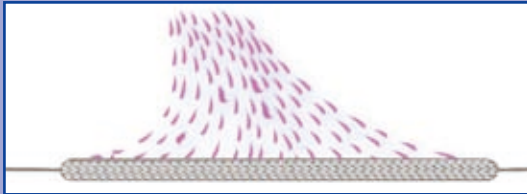

Use

- special equipment: spray booms, pipes...
- or else, use fire hoses in fog stream mode.

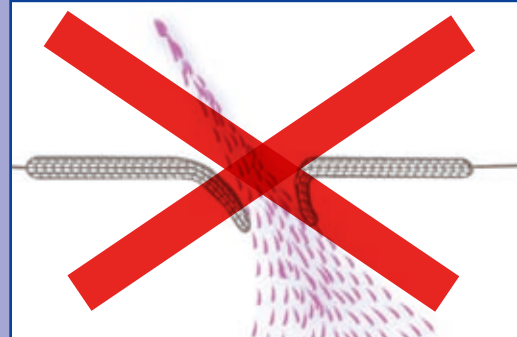

Do not use

- fire hoses in solid stream, and avoid pouring dispersant directly onto the slick.

C3

Wind can prevent dispersant from being sprayed evenly over the slick.

When using spray booms, strong wind can impair spraying quality by altering the shape of the spray and reducing spray width and even miss the oil altogether. This kind of effect will be all the more marked when dispersant is sprayed high over the slick.

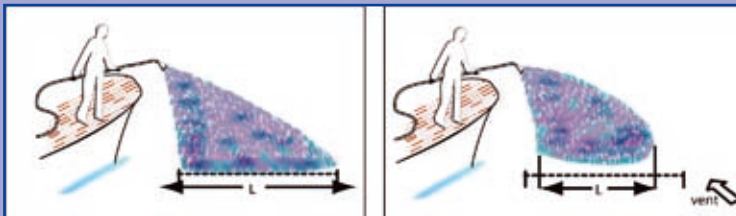
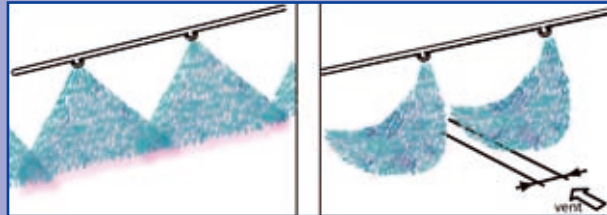

Similarly, wind can considerably reduce the range of off centred flat spray nozzles (or systems such as fan air blower).

As a rule, the preferred spraying direction is **into the wind**. However, if the wind is really far too strong to the extent that it compromises spraying operations and adequate droplet dispersion, an attempt can be made to spray downwind

but contraction may occur all the same.
cf. following page

Important note: if you are crosswind only spray from the leeward side.

Dispersant can contract surface oil.

In the event of adverse conditions, dispersants can concentrate oil into small patches or fila-

ments that stay on the sea surface instead of dispersing oil into the water column.

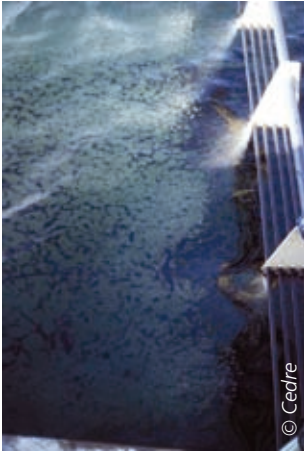

Herder effect

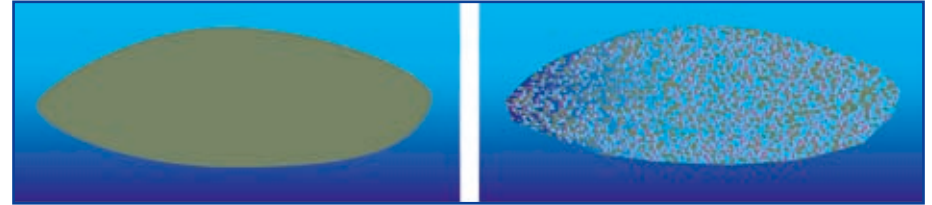

This effect will be observed when spraying dispersant downwind.

In this case, the slick is broken down into smaller patches by fine dispersant

droplets that are blown forward in front of the vessel by the wind. When the spraying booms pass over the broken slick, most of

the dispersant ends up on the water surface between the small oil patches. The preferred spraying mode is upwind (into the wind).

cf. figure C6 - page 41 - Shipborne treatment, standard approach

When this effect occurs, there is no point spraying dispersant a second time. It is always better to spray dispersant in one pass and adjust the dose accordingly.

This effect will not occur if oil is thick, emulsified and viscous.

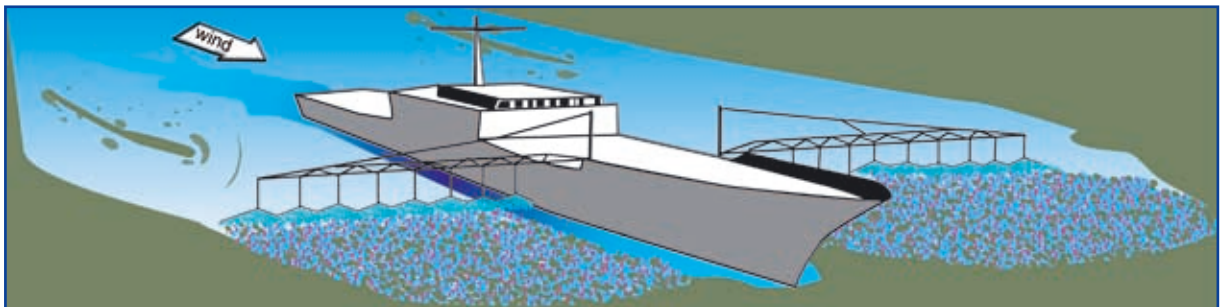

Excessive dilution can cause a dispersant to be ineffective.

If dispersant is used prediluted with seawater the percentage of dispersant in the mixture must be at least 10%.

C3

How much dispersant to use when spraying from an aircraft?

Required quantities

Required doses are of the order of 5 to 10% in relation to the amount of pollutant.

In this case, treatment rates will depend on oil thickness.

cf. B1 - Slick characteristics

Viscosity (in cSt at sea temperature)	< 500	500 – 5 000	5 000 – 10 000	> 10 000
Amenability to dispersion	<i>Usually easy</i>	<i>Usually possible</i>	<i>Sometimes possible</i>	<i>Usually impossible</i>
2 nd Conventional generation - type 1	<i>Never sprayed by aircraft</i>			
3 rd Concentrate generation - type 2 used diluted 10% in seawater				
3 rd Concentrate generation - type 3 sprayed neat % of dispersant to pollutant	5%	5 – 10%	10% (possibly 15%)	<i>Ineffective</i>

Note 1: fresh emulsion

It may be necessary to treat slicks by spraying dispersant twice at around one hour intervals. The first spraying operation will use low percentages of dispersant (1 to 2%) so as to break the emulsion and reduce viscosity. The subsequent spraying operation will effectively disperse the slick.

Except for special cases such as thick slicks (eg: 250 litres / hectare for slicks that are 250 to 500 µm thick), the treatment rate can be adjusted by changing pump speeds or by changing the nozzles and to a lesser extent by changing aircraft ground speeds (for helicopters).

The treatment rate (litres / hectare) can be worked out using the following equation:

$$\text{Rate} \simeq \frac{10^3}{3} \frac{D}{l \times v}$$

D: dispersant flow rate (in litres / minute).

v: aircraft groundspeed during treatment (in knots).

l: effective width treated: 1.2 to twice the length of the spray boom depending on the aircraft and height (in metres).

$$\text{Literal equation: } T \text{ (l/ha)} = \frac{10^4 \times D \text{ (l/min)}}{L_{(m)} \times \frac{V_{(nds)} \times 1852}{60}}$$

In practice, slick thicknesses are unknown and the usual treatment rate is 50 to 100 litres / hectare meaning average slick thicknesses (50 to 200 µm, code 4).

Important note: the effective treatment rate is always less than the equation because some of the dispersant will be blown away by the wind. Bearing such losses in mind, and especially in the event of a small patchy slick, it may be advisable to increase dispersant quantities. For instance, step up quantities from 5 to 10%.



C4

Adjusting dispersant quantities

On the ground:

- mainly by choosing other nozzles*;
- by changing pump speeds (rpm or by opening the «bypass»)*.
cf. C7 - Technical matters requiring attention prior to treatment

* Once the spray system has been adjusted, note the delivery pressure. This will turn out to be very useful subsequently for ensuring effective spraying. Pressure variations can lead to system malfunction.

In flight:

- change the flying speed (helicopter);
- some systems have several booms and the spray rates can be changed by feeding one of the booms **.

** For instance: a twin boom spraying system that can be operated independently.

How much dispersant to use when spraying from a vessel?

Required quantities

They are of the order of 5 to 10% in relation to the pollutant.

In this case, treatment rates are related to slick thickness.

Viscosity (in cSt at sea temperature)	< 500	500 – 5 000	5 000 – 10 000	> 10 000
Amenability to dispersion	<i>Usually easy</i>	<i>Usually possible</i>	<i>Sometimes possible</i>	<i>Usually impossible</i>
2nd Conventional generation - type 1	30%	30 – 50%	<i>Up to 100% slightly effective</i>	<i>Ineffective</i>
3rd Concentrate generation - type 2 used diluted 10% in seawater*	5 – 10% **	<i>Ineffective</i>	<i>Ineffective</i>	<i>Ineffective</i>
3rd Concentrate generation - type 3 sprayed neat % of dispersant to pollutant	5%	5 – 10%	10% (possibly 15%)	<i>Ineffective</i>

Note : for fresh emulsions: ➡ cf. Note 1 page 36

* The dispersant dilution rate must not be less than 10%.

** e.g., a 50 – 100% «dispersant + water» solution.

In actual fact, it is very hard to know how thick the slick is owing to enormous slick thickness variations:

- thick patches: anywhere from 0.1 mm to a few millimetres;
- vast but very thin slicks: from 0.01 to 0.1 mm.

cf. B1 - Slick characteristics

The chosen treatment rate will be about 50 to 100 litres / hectare, which would mean an average slick thickness of 0.1 mm.

To optimise dispersant quantities, the treatment rate can be changed slightly depending on how thick the slick is.

Adjusting dispersant quantities

Standard approach

To achieve a treatment rate of 50 or 100 litres / hectare, vessel speeds will have to be adjusted to suit spray system requirements.

$$v_{50\text{ l/ha}} = \frac{D}{0.15 \times l}$$

$$v_{100\text{ l/ha}} = \frac{D}{0.3 \times l}$$

v = vessel speed (knots).

D = dispersant pumping rates (neat) delivered by the system (in litres / minute).

l = width (in metres) effectively treated by the system (distance from one boom tip to another including vessel width at spray boom location).

Special cases

- Non-adjustable spray system:

The thicker patches (oil thickness > 0.1 mm) will have to be sprayed at **slower speeds** or possibly several times to increase dispersant delivery quantities (> 100 litres / hectare).

- Adjustable spray system:

With a small adjustment range (1 to 4 times the flow rate), vessel speeds will have to be varied so as to deliver at least 100 litres / hectare.

$$v = D \text{ mini} / 0.3 \text{ l}$$

Adjustable systems can facilitate the treatment of thick patches (> 0.1 mm) as delivery rates can be increased to treat such patches with one pass.

With a big adjustment range (1 to 10 times the flow rate), your best bet will be to set vessel speed so as to deliver at least 50 litres / hectare.

$$v = D \text{ mini} / 0.6 \text{ l}$$

In this case, excess dispersant can be reduced over thin patches (10 to 100 µm) that can stretch for miles on end. Thick patches (> 100 µm) can be treated with a single pass as all you need do is increase delivery rates.

C5

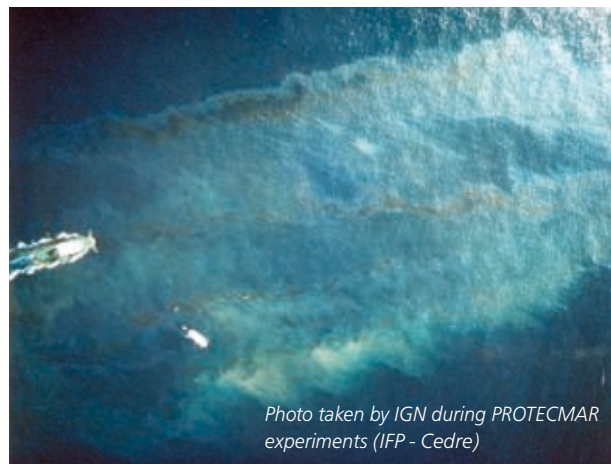

Photo taken by IGN during PROTECMAR experiments (IFP - Cedre)

How to treat a slick?

Areas to treat

Average to thick slick patches are treated by adjusting dispersant quantities sprayed.

Thin areas are not sprayed (codes 1 and 2: sheen, rainbow).

cf. B1 - Slick characteristics

cf. C4 - How much dispersant to use when spraying from an aircraft?

cf. C5 - How much dispersant to use when spraying from a vessel?

Important note: after weathering for a few days, the oil will be patchy and thick and will be called «chocolate mousse». By this stage, the oil will be so viscous as to render it impossible to disperse.

cf. A3 - When can you spray dispersants?

What to do

If you are on deck or flying low over the water you will have a hard time trying to identify the outlines of a slick not to mention slick thickness.

You will have to be methodical.

You can always decide to «revisit» thick patches that have not been dispersed later on once the bulk of the oil has been treated.

C6

DO

Begin treatment from the edges of a slick to the border of medium thickness areas

Treat the slick by parallel close passes (the only way to cover all the slick)

Treat upwind or downwind (and for vessels, always upwind) so as to guarantee spraying conditions and an optimum «dispersant-oil» contact*

For aerial application, do not forget equipment response times and droplet drift caused by the wind when you need to start or stop spraying

cf. page 43 - C6 - Start and stop spraying times

DON'T

Cut up and fragment a slick. By ploughing through it in all directions, as you will soon find it impossible to spot the slick and treat it all properly

For vessels, treat downwind

* Spray into the wind to avoid the herding effect (cf. page 35); unless when slicks are very thick and weathered and the herding effect does not occur.

Shipborne treatment

Standard approach

The preferred approach is upwind.

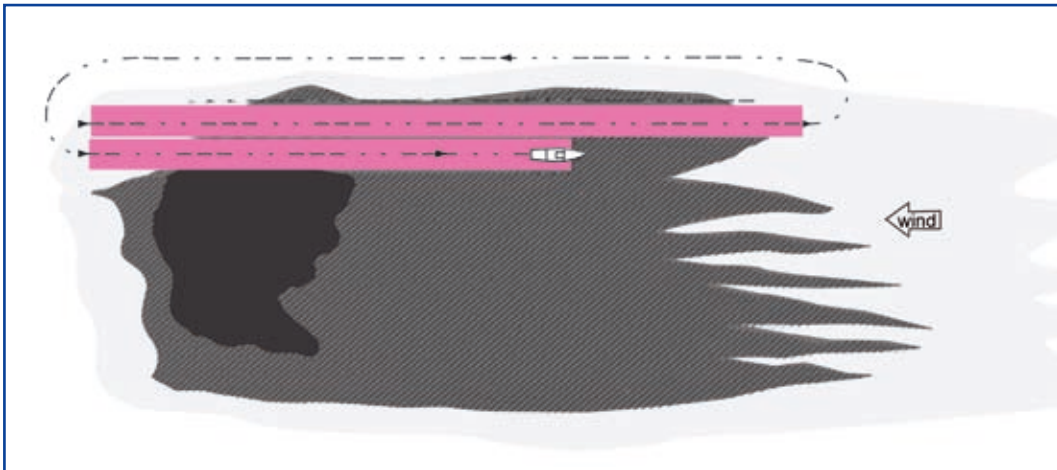

Special case

Slick is made up of a number of thin windrows placed abeam the wind: treat from the lee side of the vessel as the vessel sails lengthwise through the slick.

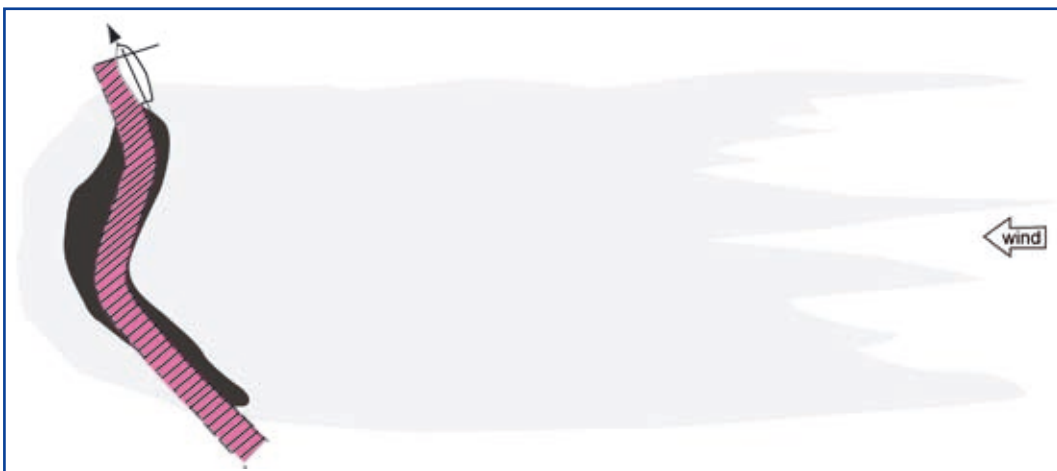

Airborne treatment

Standard approach

The preferred approach is either up or downwind.

Important note: smoke bombs can be very helpful for marking a slick and showing wind direction.

cf. box page 44 - C6 - Using smoke bombs and buoys

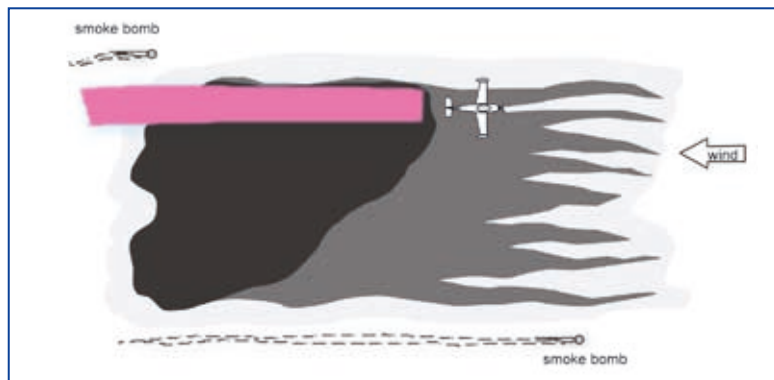

C6

Special case

If the slick is a thin strip abeam the wind: the preferred treatment modality will be to fly several passes into the wind,

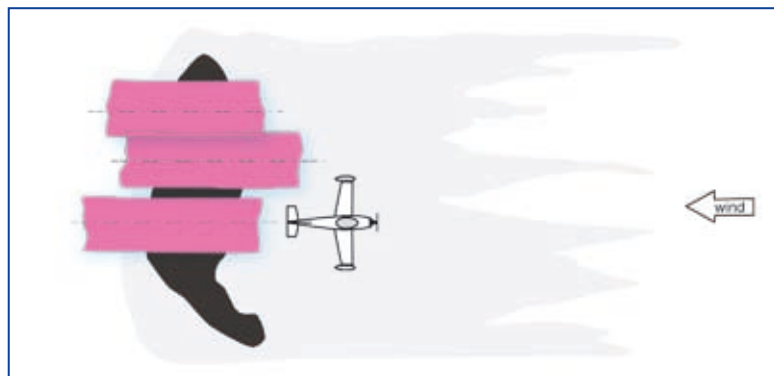

or possibly, treat abeam the wind not forgetting that the dispersant will tend to drift sideways with the wind (d).

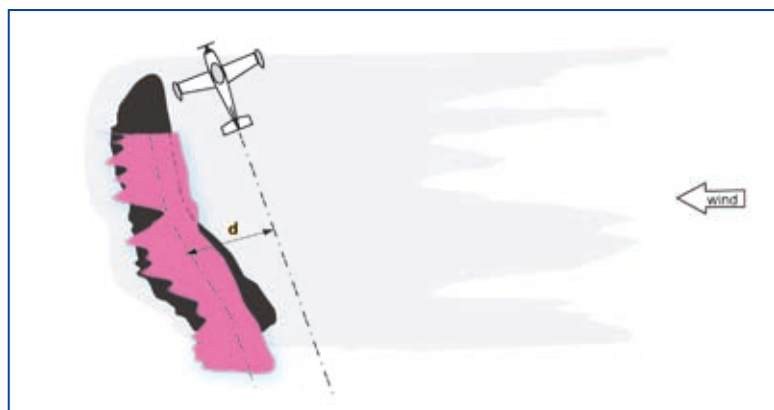

Start and stop cues

The start and stop spraying cues have to include:

- **equipment response times** for spraying to start once the cue has been given (lead time is about a few seconds) ;
- **wind effect:** as dispersant droplets fall onto the slick, the wind will blow them away. Droplet drift (in metres) can be estimated as follows:

$$d = \frac{(v \times h)}{12}$$

(Where v: wind speed in knots; h: height at which aircraft is spraying).

Flying into the wind, the effect will occur once the slick has passed. Flying downwind, the effect will occur as soon as the aircraft reaches the edge of the slick.

Quite apart from response time considerations **always start spraying 60 metres before reaching the edge of the slick, even if wind speed is low.**

C6

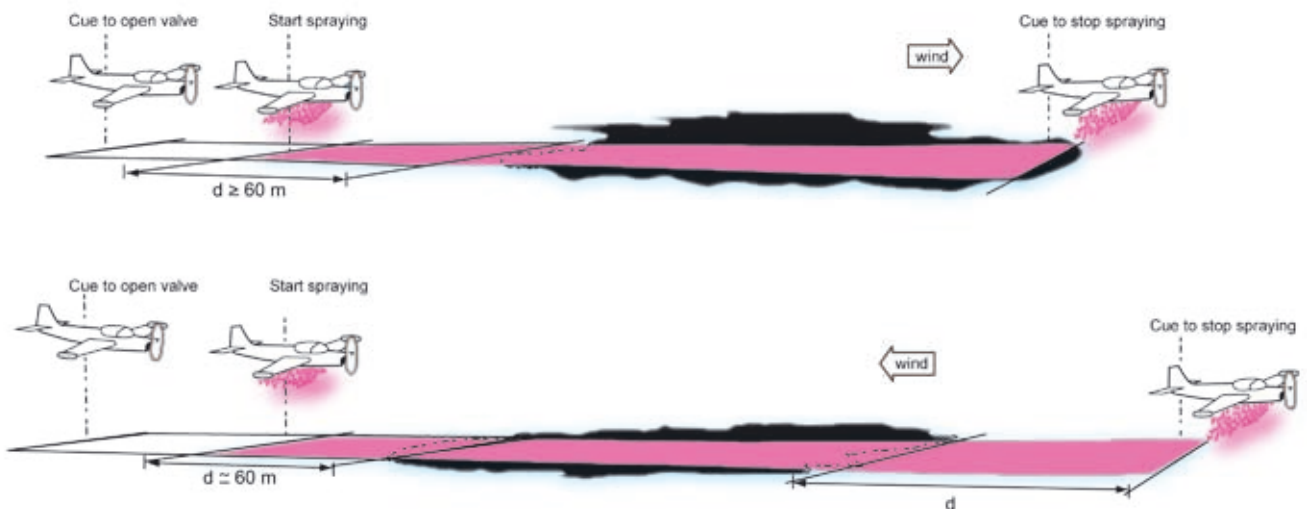

Spraying dispersant on the ground: spray downwind, spray upwind

Prior reconnaissance, guidance and marking

At low altitude (recommended for treatment) it is not easy at all to identify the slick (edges, thickness). It is always advisable to have a second aircraft flying above to guide the sprayer aircraft onto the slick and to give the cues to start and stop spraying with each pass.

If no other aircraft is available, the sprayer aircraft will have to undertake at higher altitude its own reconnaissance of the areas requiring treatment prior to commencement. The pilot will need to take his bearings which will help him during the treatment (ships in the vicinity, platforms, shorelines, buoys, smoke bombs).

Using smoke bombs and buoys

The oil slick can be marked:

- by smoke bombs dropped by the sprayer aircraft when **reconnoitring** the slick to be sprayed. Smoke bombs will also be useful to indicate wind direction;
- by smoke bombs and buoys launched from a vessel that is guided by an aircraft.



Aerial guidance procedure

Whenever dispersing or recovering oil, vessels will normally require some form of aerial guidance: as crew on board vessels have great difficulty spotting oil on the water surface, response vessels need to be guided onto the slicks in order to be effective when spraying dispersant.

The preferred modality is to provide a detailed description (with maps) of a slick where the vessel or flotilla are going to start spraying. This will avoid having to tie up a spotter plane all day.

When this is not possible, basic guidance will be taken to mean directing a vessel to the thickest parts of a slick by giving the helmsman a bearing and a distance.

For instance: «the slick is 20 metres wide and 200 metres long bearing 30° and 300 metres from your current position».

- ▶ The plane (or preferably a helicopter) has to indicate slick position and shape in addition to pointing out where the thickest parts of the slick are that will need spraying.
- ▶ Guidance can be given directly over the radio.
- ▶ When response time is limited, it is always best to give the crew on board the response vessel an exact description of the slick(s) in addition to the GPS coordinates.
- ▶ Guidance to the slick can be improved if the vessel is told where to drop marker buoys or smoke bombs.



Guidance provided by the French Customs aircraft to the French response vessel «Ailette» (Prestige spill, Galicia, 2002)

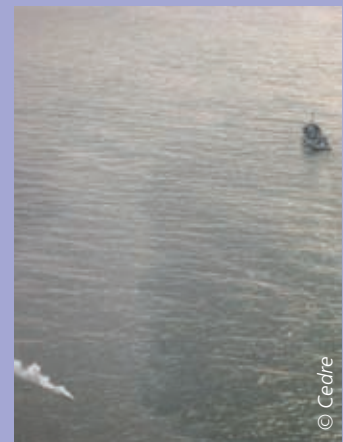

Using smoke bombs to mark slicks

Technical matters requiring attention prior to treatment

Treating slicks using aircraft

Before actually starting spraying operations, a ground test using water will show whether:

- the dispersant filter is clean;
- nozzles have been mounted correctly:
 - choosing nozzle type (possibly),
 - nozzle orientation,
- the nozzles are clogged or not;
- the check valves* (mounted just in front of the nozzles) work correctly or not;
cf. C2 - Airborne treatment
- dispersant flow rates and pressures are correct;
cf. C4 - How much dispersant to use when spraying from an aircraft?
- spraying controls (remote control) and solenoid valves are working correctly.

Shipborne treatment

Before turning the dispersant spray system on, care will be taken to:

- check that the main filter is clean;
- do a quick spray test (using water if need be) to ensure that the check valves and nozzles are clean and mounted correctly (orientation);
- check that the solenoid valves and control systems are working correctly;
- check that dispersant flow rates and pressures are correct;
cf. C5 - How much dispersant to use when spraying from a vessel?

C7

* *cf. box page 32 - Spraying equipment: nozzles and check valves*



Nozzles fitted with check valves

Precautionary measures

Response crew

Dispersants can irritate eyes and mucosa so avoid all contact with the eyes and the skin. Do not breathe aerosols.

When handling dispersants always wear protective clothing (e.g. oilskin) goggles, rubber coated gloves (recommended: rubber, nitrile; and always avoid: latex) and in the event of aerosols wear a

mask that will protect the respiratory tract (at least wear a dustproof mask).

If dispersant comes into contact with your eyes or your skin, wash them immediately with a lot of clear water.

Equipment

Dispersants are natural solvents for products such as paints, elastomers, some plastics, tar, tarmac. Depending on the product in question, it will either soften, swell or detach (eg: coatings do this).

They also have a wetting effect:

- ▶ They can soak through the smallest cracks.
- ▶ They can make some surfaces slippery (deck) and make for dangerous working conditions.

If dispersant leaks and covers the hull or the deck, spray as much water as you can.

When spraying dispersant from a vessel, it is advisable to use some kind of permanent deck or keel cooling system (e.g. use fire fighting equipment or hawser hole washing systems) to prevent crew members from falling and being injured. You will also need to connect up a fire monitor to hose down the port and starboard sections of the deck all the time and especially to hose down the catwalks.

When spraying abeam the wind from a vessel, never spray from the windward side.

When spraying from an aircraft, check from time to time to ensure that the dispersant is not jeopardising the lubrication of moving parts (such as the rotors) or any part of the command and control system.



At the end of the day, rinse spraying equipment with freshwater in addition to the immediate surroundings (plane, runway or taxiway).

If a fire breaks out

Remember dispersants are flammable. Their flash point is usually over 60°C.

If a fire breaks out, use powder extinguishers, CO₂, foam or water spray and cool the dispersant storage drums/tanks down.

Monitoring and assessment

- How do you assess treatment efficiency? _____  D1
- Monitoring and assessment procedures _____  D2

How do you assess treatment efficiency?

Visual observation

The dispersion operation is being effective if you can see a **brown-orange or even blackish cloud** (with some Heavy Fuel Oils) **beneath the surface**. This kind of cloud can usually be seen upwind of the area of the slick of medium to large thickness. The surface slick driven by the wind will drift slowly away and leave the dispersion cloud behind.

Note: the dispersion cloud will not always form immediately, particularly when the oil has weathered a bit and has emulsified a little and when wave energy is low. Moreover, the cloud will not always be easy to see and last for a long time. It may dilute and tend to disappear (once the oil has started to disperse). The dispersion cloud may form once dispersion has started but providing there is some form of wave action (crest of a wave). When spraying dispersant from an aircraft, the cloud may be harder to spot owing to the height you are flying at.

As time goes by, (minutes or hours later), the slick will break up. **Surface areas covered by thick slicks will gradually shrink (gradual disappearance of average to very thick patches, very dark colours such as dark brown or black).**

As thick slicks recede, much thinner zones appear (rainbow, codes 1, 2 or 3) which spread over large areas before declining and disappearing as time goes by (in the space of a few hours or a few days).

Note: dispersion must not be mixed up with another visible and well known effect that occurs with fresh, thin oil slicks. Once the dispersant has been sprayed the oil disappears all of a sudden. In actual fact, the dispersant has pushed the oil sideways (herder effect) because it spreads very quickly. This is not real dispersion at all because after a little while the oil film reappears.

cf. C3 - page 35 - Dispersant can contract surface oil

Infra-red remote sensing

If the dispersion operation is effective, thick patches will gradually disappear from the sea surface and **on board the remote sensing aircraft the IR scans will show less and less white patches.**

D1



1, 2 - Dispersion trial. See the beige colour of the slick just after spraying. This effect will last once a fire monitor has jetted the oil and dispersant.



3 - Effect caused by the bow wave of a vessel passing through a treated slick. See the beige colour in the foam.



4 - When the wave goes through the treated slick, oil is placed in suspension and the beige cloud forms.

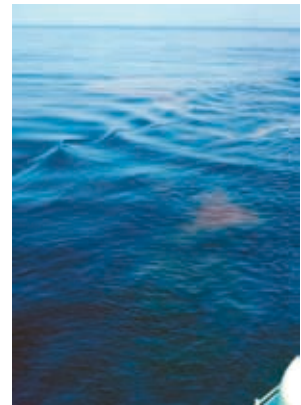
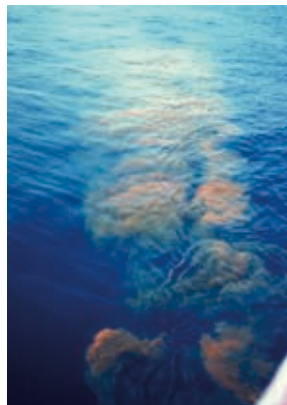

5, 6 - Dispersed oil in the wake of a vessel engaged in dispersant spraying operations.

D1



7, 8 - What the pilot sees: clouds of dispersed oil (beige) are quite distinct from the appearance of surface oil (which is black or metallic). Note on photo number 7 the presence of white foam which shows that they sprayed too much dispersant.

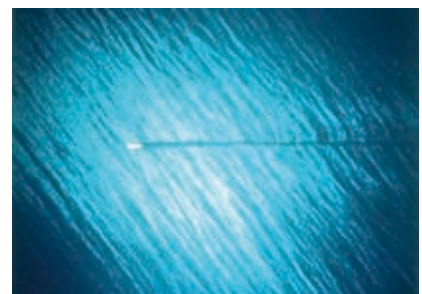

9 - Appearance of a slick treated a while ago. Thick patches have gradually subsided and only thin ones are left. (mainly sheen) and are breaking up naturally.

Photos by Cedre

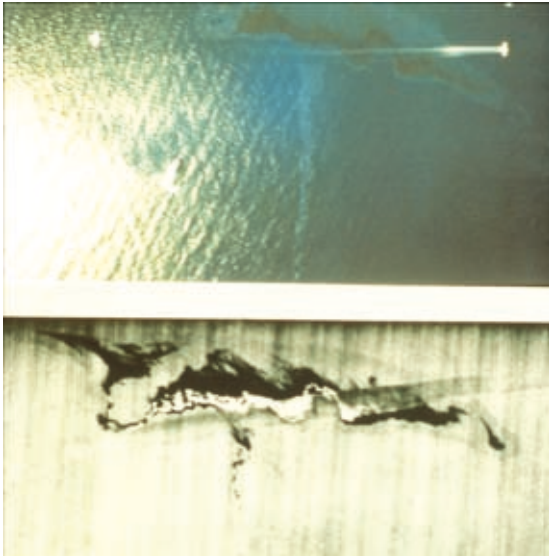

10 - A Canadair starting to spray. The bottom picture shows the same slide in a thermal IR scene. Picture taken by the remote sensing aircraft (the thickest layers are in white).

Photos 10 to 15 - Fate of a slick treated by dispersant.

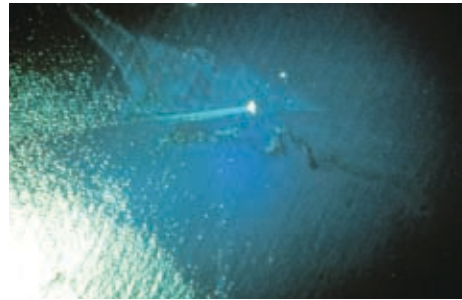

11 - Continuation of treatment. Note the appearance of a dispersion cloud (beige yellow) upwind of the thicker patches (black) and also below, temporary disappearance of thinner patches (the herder effect a dispersant can produce but this is not real dispersion in action at all).

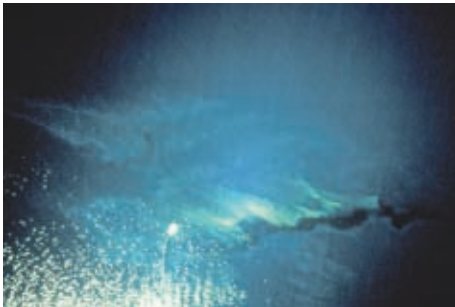

12, 13, 14 - Gradual disappearance of thicker patches that turn into dispersed oil patches (yellow brown cloud).



15 - The same slick a day after being sprayed. The dispersion cloud has dissolved into the background. All that is left is sheen which is waning and disappearing.

Photos taken by IGN during PROTECMAR trials (IFP - Cedre)

Monitoring and assessment procedures

Testing prior to large scale spraying

As a response operation swings into action but before it really gathers operational momentum, tests should be conducted on part of the slick to check that the spraying operation is likely to succeed and be effective before ramping up to full scale operations.

You will need to do aerial spraying whilst being mindful of a number of operational limitations (such as available response time) to ensure a qualitative approach to efficacy testing:

- by the spotter aircraft, but remote sensing can also be used;
- by a vessel in the vicinity; these observations have to confirm the presence of a brown coloured cloud or the gradual disappearance of thicker patches;
- otherwise, the sprayer aircraft will have to provide the input once it has finished spraying all the dispersant payload or possibly before it starts a second round.

When the response operation goes on for longer periods of time, the check will have to be done at least twice a day to ensure the oil is not weathering too much and is still amenable to dispersion.

If there is no indication that dispersion is really working, you might have to decide to stop spraying and ask yourself two questions:

- ▶ Dispersion is not producing the expected results and is this due to the nature of the oil. Has it weathered too much and is it now too viscous to be dispersed? If the answer is yes then dispersion is no longer the option you need.
- ▶ Dispersion is not producing the expected results. Is this due to very low or no wave energy at all (sea is too calm)? If the answer to the question is yes, dispersion can only really be continued providing the (very) short term weather report can announce different weather conditions likely to remedy the problem and provide more wave energy.

Monitoring operations

If response operations are going to last for a few days, you will have to take seawater samples. The sampling will have to be done in areas that have just been treated by the sprayer aircraft. The labs will check the dispersed oil content of the samples which will give an indication as to whether treatment is effective and whether dispersion is justified.

The sampling (a few decilitres) will be conducted just below the water surface and if possible no lower than one metre. The sample must be kept in a glass bottle and when the sample is transferred to the glass bottle just after sampling, the supernatant oil (from the surface slick) will have to be removed if it has been picked up inadvertently with the rest of the sample.

BIBLIOGRAPHY

INTERESTING WEB SITES

Bibliography

International Petroleum Industry Environmental Conservation Association (IPIECA).
Dispersants and their role in oil pollution response. London: IPIECA, 2001. Vol. 5.
You can download this volume from: <http://www.ipieca.org>, «Publications», in the «Oil spill response» section.

National Oceanic and Atmospheric Administration (NOAA).
Dispersant application observer job aid. Washington : NOAA.
Can be downloaded from : <http://response.restoration.noaa.gov/oilaid.html>

International Maritime Organisation (IMO).
IMO/UNEP Guidelines on oil spill dispersant application environmental considerations. London: IMO, 1995. Ref. 576E.

International Maritime Organisation (IMO).
MARPOL 73/78 consolidated edition, 2002 - articles, protocols, annexes, unified interpretations of the international convention for the prevention of pollution from ships, 1973 as modified by the protocol of 1978 relating thereto. London: IMO, 2002. Ref. 520E.

Interesting web sites

Centre de Documentation, de Recherche et d'Expérimentations sur les pollutions accidentelles des eaux (Cedre).
<http://www.cedre.fr>, « Response » section, «Response products» chapter.

International Tanker Owners Pollution Federation (ITOPF).
<http://www.itopf.com>, «Clean-up techniques», «Dispersant chemicals». You may want to read their «Country and regional profiles»: the chapter gives information on how many countries use dispersants.

Community Information System.
http://europa.eu.int/comm/environment/civil/marin/cis/cis_index.htm
This is the EU web site where indications are given as to how member states are organised to respond to accidental marine oil spills and the resources they have.

Bonn Agreement.
<http://www.bonnagreement.org>
World class regulations : dispersant certification.

Environmental Protection Agency (US-EPA).
<http://www.epa.gov>
Dispersant certification.

Regional Marine Pollution Emergency Response Centre for the Mediterranean Sea (REMPEC).
<http://www.rempec.org>
Dispersant certification.

Regional Organization for the Protection of the Marine Environment - Kuwait (ROPME).
<http://www.ropme.com>
Regional regulations.

European Maritime Safety Agency (EMSA).
<http://www.emsa.europa.eu>

GLOSSARY

<i>Cedre</i>	Centre de documentation, de recherche et d'expérimentations sur les pollutions accidentelles des eaux.
Density	Quotient of the volume mass of a substance and that of water, for a liquid, and that of air, for a gas.
Dispersant	A chemical intended to facilitate dispersion of oil in the water column. These products contain surfactants (active ingredient) and hydrocarbon solvents intended to facilitate the diffusion of a surfactant in oil.
Dispersion	Formation of oil droplets through wave action or surface turbulence of varying sizes and that stay in suspension in the water column or that upwell behind the slick and reform another slick. Depending on how viscous the oil is and if the geographical and bathymetrical context permit, this natural phenomenon can be enhanced by the use of dispersants.
Emulsification	This means the formation of a reverse «water-in-oil» emulsion that can often contain 60 to 80 per cent water. The emulsion is brown to orange and is usually called «chocolate mousse» because it is just as viscous as «chocolate mousse».
Evaporation	Transformation of a liquid into vapour at a given temperature. Evaporation rates depend mainly on the proportion of volatile compounds in oil in addition to factors such as wind speed, temperatures, surface agitation and spreading. The less volatile fractions form high density and high viscosity residues, far higher than natural oil.
MOTHY	Mothy stands for «Modèle Océanique de Transport d'Hydrocarbures» (Ocean Model for Oil Transport) and was designed by the French Weather Bureau to forecast oil slick drift and drift patterns of flotsam and jetsam.
Heave	Repeated vertical movements of a ship's bow when it hits the sea.
Pour point	Temperature below which a liquid will no longer pour in lab conditions (calibrated tube). The pour point does not indicate a temperature whereby a liquid solidifies, it refers to the temperature whereby a liquid becomes too thick to pump.
Flash point	The lowest possible temperature at which vapour concentrations are sufficient to warrant an explosion when in contact with a flame or a hot spot. An oil will be very flammable when the flash point is below 0°C, and readily flammable when the flash point is between 0 and 21°C and flammable when it is between 21 and 55°C.
Remote sensing	Techniques consisting of detecting and identifying phenomena/objects at a distance. In the case of aerial observation of oil slicks, remote sensing requires sensors such as the SLAR and the FLIR, infra-red and ultra violet scanners in addition to microwave radiometers.
Surfactant	A surfactant is a molecule that reduces natural repulsion between two substances. They enhance the wettability of a solid by a liquid, in addition to spreading or placing in suspension of an oily liquid on or in an aqueous medium.
Viscosity	The extent to which a liquid will resist being poured. A unit of measure (centistoke) representing 1 / 100th of a stoke (St), which is the fundamental unit of kinematic viscosity (cSt). Fluid water has a viscosity of 1 cSt, diesel has a viscosity of about 10 cSt and engine oil (at 20°C) 100 cSt. HFO is far thicker and can reach several thousand cSt.

Centre de documentation, de recherche et d'expérimentations
sur les pollutions accidentelles des eaux

715, rue Alain Colas, CS 41836, F 29218 BREST CEDEX 2

Tel. +33 (0)2 98 33 10 10 - Fax +33 (0)2 98 44 91 38

Email : contact@cedre.fr - Internet : <http://www.cedre.fr>



© Cedre - 2005